



Cedar 5

Multi-fuel stove

Ref No: S107.

ECO 2022 Ready

Version 02 (17.02.2020)

Installation and Operating Instructions

The Cedar 5 stove must be installed by a suitably qualified engineer. Instructions must be given to the user when installation is complete, and the installer must instruct user of the correct use of the appliance and control operation.



UK | **UK**
CA | **NI**

Table of Contents

THE CLEAN AIR ACT 1993 AMD SMOKE CONTROL AREAS.....	3
PRODUCT SPECIFICATION	4
IMPORTANT INFORMATION ABOUT INSTALLATION AND USING THE STOVE	6
UNPACKING & ASSEMBLY	7
INSTALLATION OF THE STOVE	8
MATERIAL CLEARANCES	8
FLOOR	8
THE CHIMNEY	9
FUME EMISSIONS	9
OPERATING INSTRUCTIONS	10
THE CONTROLS	10
FUEL	11
BEFORE LIGHTING	11
LIGHTING A WOOD FIRE	11
REFUELING PROCEDURE.....	12
DE-ASHING THE STOVE	13
GUIDANCE ON SAFE OPERATION	14
FIRE CAN BE VERY DANGEROUS	14
CHIMNEY FIRE	14
FUMES	14
ADVERSE WEATHER CONDITIONS.....	14
MAINTENANCE	15
CLEANING.....	15
GENERAL MAINTENANCE	15
STOVE BODY	15
FIRE ROPE.....	16
CLEANING THE STOVE.....	16
STOVE GLASS	16
CHIMNEY	16
FAULT FINDING.....	17
FIRE WILL NOT BURN	17
SOOT BUILD UP ON GLASS.....	17
EXCESSIVE WEAR ON INTERNAL PARTS.....	17
SPARE PARTS	18
PART LIST	19

THE CLEAN AIR ACT 1993 AMD SMOKE CONTROL AREAS

Under the Clean Air Act local authorities may declare the whole or part of the district of the Authority to be a smoke control area. It is an offence to emit smoke from a chimney of a building, from a furnace or from any fixed boiler if located in a designated smoke control area. It is also an offence to acquire an "unauthorized fuel" for use within a smoke control area unless it is used in an "exempt" appliance ("exempted" from the controls which generally apply in the smoke control area).

In England appliances are exempted by publication on a list by the Secretary of State in accordance with changes made to sections 20 and 21 of the Clean Air Act 1993 by section 15 of the Deregulation Act 2015. Similarly, in Scotland appliances are exempted by publication on a list by Scottish Ministers under section 50 of the Regulatory Reform (Scotland) Act 2014. In Wales and Northern Ireland these are authorised by regulations made by Welsh Ministers and by the Department of the Environment respectively. Further information on the requirements of the Clean Air Act can be found here:

<https://www.gov.uk/smoke-control-area-rules>

Your local authority is responsible for implementing the Clean Air Act 1993 including Designation and supervision of smoke control areas and you can contact them for details of Clean Air Act requirements. The Cedar 5 has been recommended for burning wood logs in a smoke control area. The Cedar 5 must be fitted with a permanent stop preventing closure of the secondary controls beyond 5mm and the tertiary air controls beyond 3mm open.

**THANKS FOR BUYING OUR STOVE, PLEASE READ THESE
INSTRUCTIONS CAREFULLY**

For your safety it is very important that your stove is correctly installed. Take care when assembling and moving the stove. It is made of cast iron and is very heavy (**75 kgs**)

The **Cedar 5** has been recommended as suitable use in smoke control areas when burning wood and Maxibrite.

A CO monitor is required to be installed in the same room as the appliance.









PRODUCT SPECIFICATION

Item No.		Cedar 5
Weight		75KGS
Dimensions (WXDXH)mm		430(max footprint/exc handle) X297.5 (max footprint/exc handle) X494.5(exc flue)
Flue size		125mm
Wood Logs Results, 0.83 hour refuels		
Parameter		Mean
Test duration	h	0.83
Total efficiency	%	80.7
Nominal heat output	kW	5.1
Mean CO ² emission	%	11
Mean CO emission	%	0.14
Mean CO emission (at 13 % O ₂)	%	0.10
Mean flue gas temperature	°C	278
Flue gas mass flow	g/s	3.9
Mean C _n H _m emission (at 13 % O ₂)	Nmg/m ³	79
Mean NO _x emission (at 13 % O ₂)	Nmg/m ³	109
DIN Plus particulates (at 13 % O ₂)	Nmg/m ³	11

Provisional Maxibrite Results, 1.0 hour refuels		
Parameter		Mean
Test duration	h	1.03
<i>Total efficiency</i>	%	79.0
<i>Nominal heat output</i>	<i>kW</i>	5
Mean CO ² emission	%	11.1
Mean CO emission	%	0.11
Mean CO emission (at 13 % O ₂)	%	0.07
Mean flue gas temperature	°C	290
<i>Flue gas mass flow</i>	<i>g/s</i>	3.6
Mean C _n H _m emission (at 13 % O ₂)	Nmg/m ³	29
Mean NO _x emission (at 13 % O ₂)	Nmg/m ³	114
DIN Plus particulates (at 13 % O ₂)	Nmg/m ³	13

Please note that details and specifications contained herein are correct at the time of going to print. We reserve the right to change specifications at any time without prior notice.

IMPORTANT INFORMATION ABOUT INSTALLATION AND USING THE STOVE

-  All national and local regulations, including those referring to national and European standards, need to be complied with when installing the stove.
-  The stove must be installed by a registered installer or approved by your local building control officer.
-  Only use for domestic heating purposes only.
-  Burn only approved fuels (Wood or manufactured smokeless fuel). Do not use petroleum based products or use as an incinerator.
-  This stove will become very hot whilst in operation and due care should be taken. Thick gloves should be used to operate the primary/secondary controls or reaching inside the stove to position fuel or remove ash. Do not place flammable objects on or near the stove.
-  It is possible to fire the stove beyond its design capacity. This could damage the stove, so watch for signs of overfiring - if any part of the stove starts to glow red, the stove is in an overfire situation and the controls should be adjusted accordingly. Never leave the stove unattended for long periods without first adjusting the controls to a safe setting. Careful air supply control should be exercised at all times.
-  The stove must NOT be installed into a chimney that serves any other appliance and is suitable for intermittent burning.
-  Do not make unauthorised changes or modifications to the stove.
-  The stove and chimney flue must be regularly cleaned. It is especially important to check for blockages following a prolonged shutdown period. It is recommended that the stove and flue is regularly maintained by a competent engineer.

UNPACKING & ASSEMBLY

Warning: Due to the weight of the stove it is recommended that two people perform the unpacking and assembly

1. Unpacking

Before assembling, place check contents against the following list and advise your dealer immediately if any parts are missing.

- 1 x Stove body
- 1 x Flue Connector c/w Fireproof Gasket
- 1 x Firebox Top Baffle Plate A
- 1 x Firebox Top Baffle Plate B
- 1 x Flue Blanking Plate
- 1 x Ash pan & Handle
- 1 x Grate
- 1 x Fixings Kit
- 1 x Heat Resistant Glove
- 1 x Vermiculite plate set



2. Assembly

Unpack the stove and remove packing materials. Open the door and remove ashpan, flue adaptor and fixing kit from inside the stove.

1. Sit the stove upright and attach the flue adaptor as showed picture below, using the screws supplied. Ensure the fireproof gasket is correctly seated in the base of the flue adaptor.

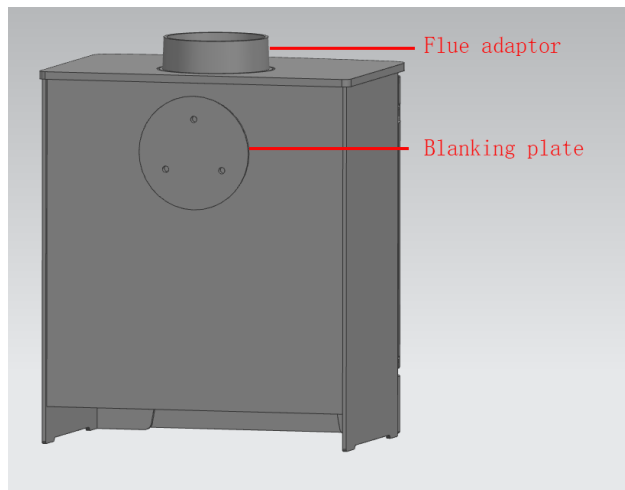

2. Install the blanking plate in the rear of the stove when the normal flue exit is required.

If the rear mounting flue configuration is to be used, the blanking plate will be fitted to the top of the stove and the flue connector to the rear panel.

INSTALLATION OF THE STOVE

PLEASE READ THESE INSTRUCTIONS CAREFULLY



For your safety it is very important that your stove is correctly installed. Our Stoves cannot accept any responsibility for any fault arising through incorrect installation or use.

MATERIAL CLEARANCES

The stove must have a minimum clearance to a combustible below.

Fig 4

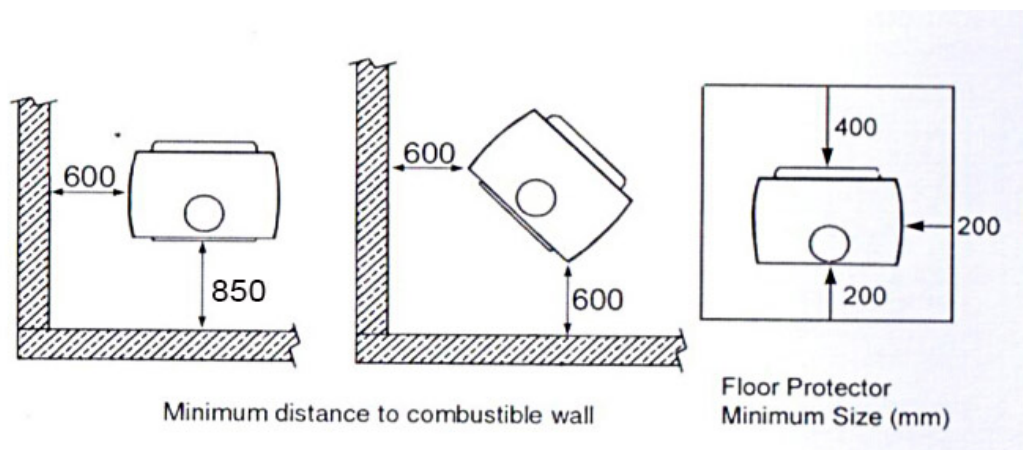

It is recommended that the stove be installed at least 600mm from combustible materials. However, any household furnishings should be at least 1000mm away as they could be adversely affected by heat.

If the stove is to be installed in a non-combustible recess it is recommended that 50mm clearance is left at the back, sides and top for maintenance and to allow air to circulate around the stove to obtain a reasonable output. A clearance of 150mm will give a better heat output.

Due to the heat of a hot stove, a suitable fire guard should be used to provide additional protection. Never allow young children to be left unsupervised in a room containing a hot stove.

FLOOR

National and local building regulations must be complied with when considering the floor or hearth where the stove is to be installed. The floor must be capable of bearing the weight of the stove and the maximum hearth temperature measured on testing was 111 deg C on full fire.

THE CHIMNEY

The stove is supplied with a flue pipe connector for top or rear mounting with the fixing screws supplied. The stove should never be connected to a shared chimney/flue system.

The chimney height and the position of the chimney terminal should conform to Building Regulations. Minimum chimney height is 4.5m and the recommended minimum diameter is 125mm. The chimney must be swept before connection to the stove. Check that the chimney is in good condition, dry and free from cracks and obstructions. The diameter of the flue should not be less than 125mm (spigot diameter) at any point and not greater than 200mm.

Flue pipes with a smaller cross-sectional area than that of the stove outlet should never be used. Flue pipes must not project into the chimney connector, such as to cause a restriction to the gas flow.

Consideration must be given to installing extra access in the flue system to ensure all sections can be cleaned and maintained.

FUME EMISSIONS

To avoid chimney problems, your fire should not be burnt slowly for longer than 12 hours without a period of fast burning.

Properly installed and operated, this stove will not emit fumes. Occasional fumes from de-ashing and refueling may occur. Persistent fume emission must not be tolerated. If fume emission persists, the following immediate action should be taken:

1. Open doors and windows to ventilate room.
2. Let the fire out or eject and safely dispose of fuel from the stove.
3. Check for flue chimney blockage and clean if required.
4. Do not attempt to re-light the fire until the cause has been identified and corrected.
5. If necessary, seek professional advise.

OPERATING INSTRUCTIONS

THE CONTROLS

The amount of heat emitted by the stove is regulated using the air control built at front of the stove.

using primary air when burning mineral fuel and secondary air when burning wood. The need for de-ashing the appliance more frequently when burning mineral fuel.

By adjusting the degree to which the primary air and air-wash vents are opened, good control of the combustion is being established.

The “air-wash” feature when used, should function to effectively keep the inside of the door glass clear of smokey deposits.

WARNING:

 **The temperature reached by these items during operation may cause an injury to an end-user. As these are intended to be adjusted during operation, it is recommended that protective gloves are worn when handling these parts.**

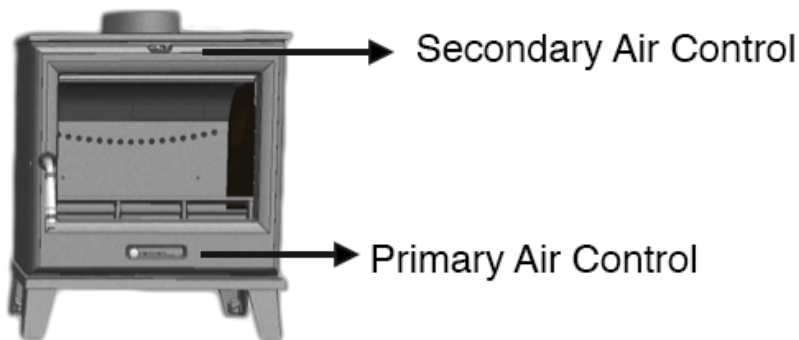

- Push Air Controls to the right to open.
- Push Air Control to the left to close.

FUEL

This stove will function with wood or manufactured smokeless fuel, but in general all fuel should be dried, and timber should be well seasoned so as to have a moisture content below 20%. The use of damp wood will result in more soot and tar deposits being left in the chimney, flue and stove, and will not release heat if thermal energy is being used to drive out moisture from the fuel.

DO NOT BURN wet or unseasoned wood, construction timber, painted or treated wood, driftwood or manufactured board products. Doing so will result in the wood burning inefficiently and excess smoke, soot and tar will be produced. This will coat and damage the internal components of the stove and flue and could result in a chimney fire.

BEFORE LIGHTING

If using for the first time or following a long period out of use check that the flue is clear and unobstructed.

Check that the ash pan is empty and in position.

WARNING:



During the first few times the stove is used, the heat resistant paint will be curing, and may give off small amounts of smoke and odours. This is completely normal for this type of appliance, and the room should be well ventilated.

To aid this process and not damage the stove finish, the first few times a new stove is used the fire should be kept to a moderate size, and not fired vigorously.

LIGHTING A WOOD FIRE

1. Place 2 or 3 firelighters or screwed up newspaper onto the fire grate with about 1 kg of kindling and light the fire with a taper.
2. When the firelighters or newspaper are burning, leave the door ajar about 1 to 2 cm to achieve a good draw and avoid condensation. Allow the burning kindling to warm up the chimney.
3. After 2 to 5 minutes the chimney should be warm enough create a good draw and the door can be closed but leave air control open (the control wheel on the door).
4. Once the kindling has formed a good bed of glowing embers the stove can be refueled with 4 or 5 pieces of wood with an approximate size of 200mm by 100mm. (*do not be tempted to overfill the firebox and risk fuel falling onto the glass or out the fire as the door is opened*).

WARNING:



When opening the door always open gently for the first 2 to 3 cm to allow the pressure to equalise and stop smoke from escaping.

The stove should not be operated with either door left open for long periods.

The stove door should never be left open when the stove is in use.

Under normal chimney draft conditions expect to refuel the stove every 45 to 60 minutes.

REFUELING PROCEDURE

Always refuel onto hot embers. If there is insufficient burning material in the fire-bed to light a new fuel charge, excessive smoke emission can occur. Refueling must be carried out onto a sufficient quantity of glowing embers and ash that the new fuel charge will ignite in a reasonable period. If there are too few embers in the fire-bed, add suitable kindling to prevent excessive smoke.

WARNING:



Directly after re-fueling, it was necessary to operate with the door ajar for a period of 2-3 minutes in order to maintain flames on the new re-fuel charge.

Do not leave the fire unattended until the flames are well established on the newly charged logs

It is important to follow these instructions in order to achieve clean burning and to maximise the efficiency of the stove.

The stove must not be overloaded with fuel. Overloading can cause excess smoke. Following the above procedure will maximise the performance of the stove. Typically, the four logs will burn with an attractive flame pattern and will last for about an hour (although this will depend on weather conditions, e.g. whether it is windy, and specific installations, e.g. chimney dimensions)

WARNING:



If there is insufficient burning material in the fire bed to light a new fuel charge, excessive smoke emission can occur. Refueling must be carried out onto a sufficient quantity of glowing embers and ash that the new fuel charge will ignite in a reasonable period. If there are too few embers in the fire bed, add suitable kindling to prevent excessive smoke

The maximum amount of fuel specified in this manual should not be exceeded, overloading can cause excess smoke.

Operation with the door open can cause excess smoke. The appliance must not be operated with the appliance door left open except as directed in the instructions.

Operation with the air controls or dampers open can cause excess smoke. The appliance must not be operated with air controls or dampers door left open except as directed in the instructions

DE-ASHING THE STOVE

Before de-ashing the stove, make sure that all the fuel has burned out and the ashes has cool down, then use a brush let the ash fall from bed of the fire into the ash pan underneath. Then take out of the ashpan in this case, if you have a special ash vacuum cleaner, Suck the ash into the vacuum cleaner directly.

If the stove is still burning when you want to de-ash the stove, make sure that you take a heat resistant glove and use special tools for cleaning. Brush and vacuum cleaner are not suitable in this case.

WARNING



Take great care when removing and emptying the ash pan. It may be very hot and still contain burning or smouldering embers and is a fire risk.

GUIDANCE ON SAFE OPERATION

FIRE CAN BE VERY DANGEROUS

During operation, the stove and all the fittings (door handles and controls) get very hot.

DO NOT OVER FIRE THE STOVE

It is possible to fire the stove to such an extent that damage may occur. Look out for parts of the stove or flue glowing red hot. If such a situation occurs adjust the air supply accordingly to reduce the burning rate.

CHIMNEY FIRE

In the event of a chimney fire:

1. Shut all air controls immediately
2. Raise the alarm and evacuate the building
3. Call the fire brigade
4. Do not re-enter the building

FUMES

1. If installed, operated and maintained correctly the stove will not emit fumes into the room other than occasionally very small amounts when re-fuelling or de-ashing.
2. If fumes are being emitted during normal operation, ventilate the room by opening all doors and windows.
3. Let the fire burn out
4. Leave the room
5. Check the stove, flue and chimney for blockages
6. Do not re-use the stove until the cause of the problem has been identified and rectified.
7. If required seek expert help.

ADVERSE WEATHER CONDITIONS

In a small number of installations, very occasionally in specific weather conditions (direction of wind) the draw of the chimney may be affected causing a downdraught and fumes to be emitted into the room.

If this is the case the stove should not be used and advice sought from a professional flue installer who would be able to advise on possible solutions such as an anti-downdraught cowl.

MAINTENANCE

CLEANING

The inside of the stove may require regular cleaning, especially during periods of peak use, the frequency of this being indicated by experience. It is advisable to wear a dust mask, protective gloves and safety glasses when cleaning.

Use a stiff brush and industrial type vacuum cleaner to dislodge and remove as much material as possible, starting at the top of the stove and working down to the bottom. Particular attention should be given to the air inlet controls which can become obstructed. A CVAC Ash Can filter can vacuum cleaner is ideal for this process.

GENERAL MAINTENANCE

Take this opportunity to check for any damaged parts inside the stove. In the event of damage or broken components, replacements can be obtained from your local distributor. On no account should unauthorised spare parts be used.

The stove and flue way should be inspected and maintained when in a cold condition. No unauthorised modification of this product should be carried out. This stove requires regular maintenance by a competent engineer.

STOVE BODY

The stove is finished with a heat-resistant paint which can be cleaned with a soft brush. Wait until the stove has cooled down before doing this. This finish can be renovated with stove paint from authorised supplier, although the paint may not be an exact match and it may be necessary to repaint the complete stove/

If the stove is purely ornamental, painting will provide a durable, attractive finish. If the stove is used for heating, a high temperature heat resistant paint must be used, in either aerosol or brush applied form. Should rust become apparent, clean thoroughly with a wire brush and apply a suitable anti-rust treatment.

During prolonged periods out of use, the air inlets should be left open and the door left slightly ajar in order to circulate fresh air and discourage condensation from forming which could encourage corrosion.

FIRE ROPE

Check the rope around the door and glass, if rope is becoming detached, replace with rope approved for this purpose.

Inspect the fireproof door seals where fitted, to ensure there is an effective seal around the door and re-fix it if loose using stove rope adhesive. If in poor condition it should be replaced.

CLEANING THE STOVE

Clean the outside of the stove with a soft brush.

Note that if required the flue can be accessed for cleaning from inside the stove.

STOVE GLASS

Clean any glass panels when cool, avoiding abrasive substances which could scratch the glass and make subsequent cleaning more difficult. Wet logs against a heated glass, a badly aimed poker or heavy slamming of the doors could crack the glass panels. The glass will not fracture with heat. Never replace any broken glass with glass not approved for use with cast iron stoves.

The window glass should remain clean during normal use but it can become blackened if the stove is being operated with either damp fuels or at a slow burn rate. The blackening may be dispersed by burning firefly at a much higher temperature, or it may be cleaned off using specialist glass cleaner.

In the event of the glass being broken, it can be removed by unscrewing the retaining clips, taking care not to damage the fireproof seal. The replacement glass should be carefully placed against the seal and the retaining clips re-tensioned. Take care to tension these evenly or there is a risk of breaking the new glass pane.

CHIMNEY

It is important to have the chimney cleaned at least once a year.

Regular inspection and cleaning of the internal components of the stove can indicate if the chimney requires more frequent cleaning.

If the stove has been unused for an extended period (during the summer) the chimney should be checked by a competent person before use.

Note:

All parts that are in direct contact with the fire (grate, Baffle, back or side air boxes) are considered as normal wear parts. Their life will be depended on how vigorously the stove is operated and they must be inspected and maintained on a regular basis. If they become worn, damaged or not positioned correctly, non-wear parts such as the stove top and sides will be exposed to excessive heat and may be damaged. Only use replacement parts recommended by the manufacturer.

FAULT FINDING

FIRE WILL NOT BURN

1. The fuel is too wet and not suitable
2. Air inlets to the stove are blocked
3. The flue is blocked or restricted
4. Inadequate air supply into the room

SOOT BUILD UP ON GLASS

1. Fuel is too wet
2. Fuel pieces are too large and “smouldering” rather than burning.
3. The stove operating temperature is too low
4. The stove is being run too “slow” with not enough air
5. Poor chimney draft

EXCESSIVE WEAR ON INTERNAL PARTS

1. Stove fired too vigorously
2. Too little air passing through the bottom grate
3. Use of wood that is too dry (e.g. wood from old furniture)

SPARE PARTS

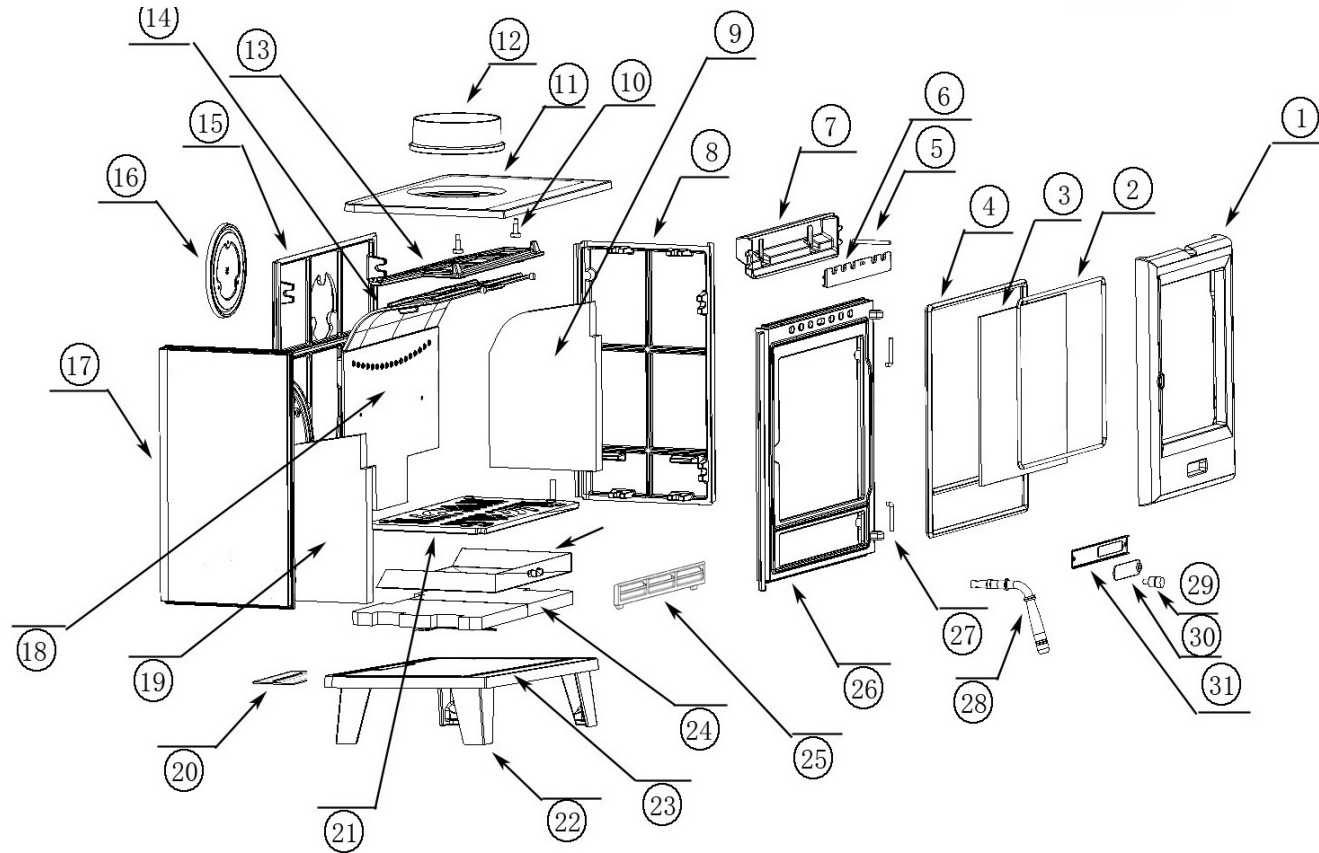

NOTE: For all spare parts enquiries visit www.firespares.direct or call (0191) 4974280

PART LIST

Number	Part name	Qty
1	Door	1
2	Glass seal rope	1
3	Glass	1
4	Door seal rope	1
5	Top slider knob	1
6	Top slider	1
7	Air wash box	1
8	RH side panel	1
9	RH vermiculate board	1
10	Upper baffle retainer screw	2
11	Top lid	1
12	Spigot	1
13	Upper baffle	1
14	Lower baffle	1
15	Rear panel	1
16	Blanking plate	1
17	LH side panel	1
18	Rear lining	1
19	LH vermiculate board	1
20	Tertiary air plate	1
21	Grate	1
22	Leg	4
23	Bottom panel	1
24	Bottom vermiculate board	2
25	Front log retainer	1
26	Front frame	1
27	Hinge Pin	2
28	Handle	1
29	Bottom slider knob	1
30	Bottom slider	1
31	Bottom slider retainer	1

NOTE: For all spare parts enquiries visit www.firespares.direct or call (0191) 4974280